

This guide is for the R1405 /R1407 Rinnai INFINITY metal recess boxes, refer INFINITY model suitability on p.4.

This guide is designed to be used in conjunction with the NZ Building Code Approved Document - External Moisture E2. The recess box installation can be compared to the detail required to install a meter box.

Local authorities may have their own additional requirements regarding this type of installation. If in any doubt over compliance with building codes, it is advisable they are consulted prior to installation.



INFINITY metal recess box Installation guide

Rinnai

Important

The recess box shall be installed in accordance with:

- Manufacturer's installation instructions
- Current AS/NZS 3000, AS/NZS 3500, AS/NZS 5601.1, G12/AS1, and E2 AS1 Fig 69

Installation, servicing and repair shall be carried out only by authorised personnel.

Warning

Improper installation, adjustment, alteration, service and maintenance can cause property damage, personal injury or loss of life.

For more information about buying, using, and servicing of Rinnai appliances call: 0800 RINNAI (0800 746 624).

Rinnai New Zealand Limited
105 Pavilion Drive, Mangere, Auckland
PO Box 53177, Auckland Airport, Auckland 2150

Phone: (09) 257-3800
Email: info@rinnai.co.nz
Web: rinnai.co.nz
[youtube.com/rinnainz](https://www.youtube.com/rinnainz)
[facebook.com/rinnainz](https://www.facebook.com/rinnainz)

Contents

About the metal recess box.....	4
Dimensions.....	5
R1405 metal recess box kit contents.....	6
R1407 metal recess box kit contents.....	7
Installation steps.....	8
Fitting the EF26 / HD49kWe.....	10
Flue terminal clearance positioning diagram.....	11

Installer please note

These instructions are for the tradespeople installing the recess box and continuous flow water heater. If you are not installing the water heater, please leave these instructions, and any other kit components not used inside the recess box. It is important that the gasfitter installing the water heater has access to the information and components required to fit the water heater inside the box.

About the metal recess box

The Rinnai INFINITY recess box enables an external continuous flow gas water heater to be recessed, either fully or semi-recessed into an external wall, behind a door and out of sight.

Construction and colour

Folded galvanised steel, powder coated white—can be painted to match the exterior cladding.

Suitability

Outdoor installations only.

Suitable for the following external Rinnai INFINITY water heaters:

- **R1405 recess box**
A-Series (A16-A26) current range
- **R1407 recess box**
HD49kWe, HD250, EF26 current range



Designed for new builds or major renovations. Installation needs to commence during the framing stage, before internal lining, cladding, or building wrap is applied.

Clearance requirements

The location of the flue terminal must comply with the AS/NZS 5601.1 Fig 6.2. If you do not have access to this document, we have produced a simplified diagram highlighting the main clearances on p.11.

Position

Some considerations when installing a Rinnai recess box with an external continuous flow water heater.

Operating noise	A Rinnai INFINITY gas water heater inside a recess box operates at a slightly louder level than a unit installed on an outside wall. Please keep this in mind when positioning near a bedroom as the operating noise could affect some people.
Hot water outlets	In most cases it's better to site the recess box closer to the kitchen where there is an expectation for instant hot water.
Obstructions	Ensure there are no plumbing, electrical wires, timber, or other objects blocking the box or inside the cavity.
Accessibility	Make sure the unit is accessible for maintenance and servicing.

Flashing details

On the Rinnai website (rinnai.co.nz), type '*metal recess box*' into the search field. In the 'Technical' tab of the metal recess product page are PDF's detailing the flashing details based on different cladding options.

Dimensions (mm)

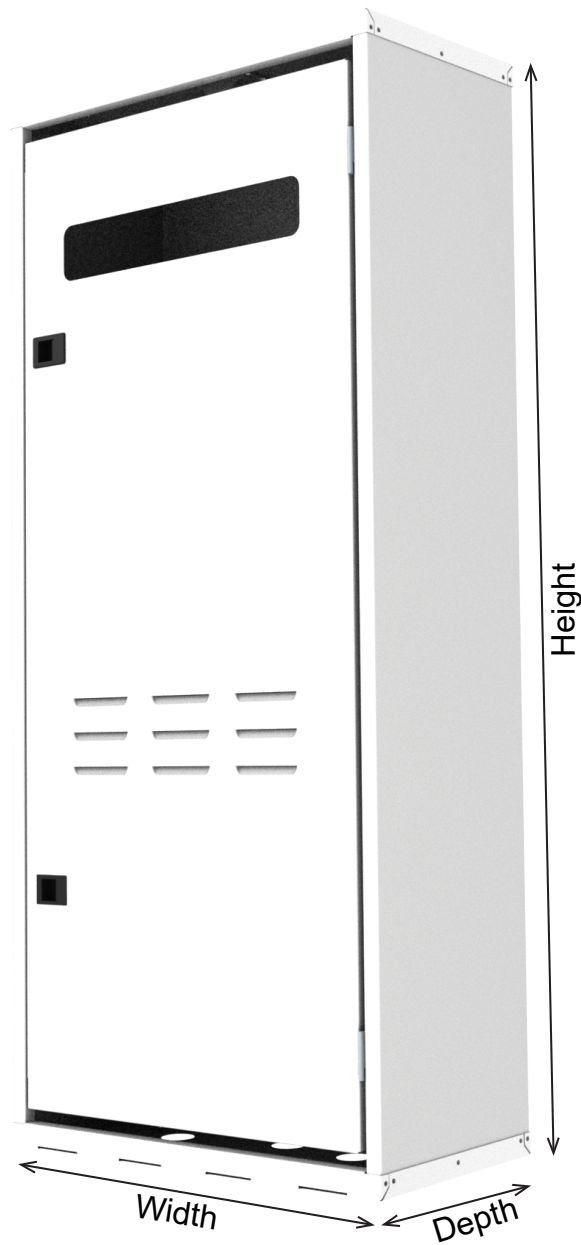

	R1405	R1407
Height	945 mm	945 mm
Width	417 mm	514 mm
Depth	205 mm	270 mm

R1405 metal recess box kit contents

A16-A26

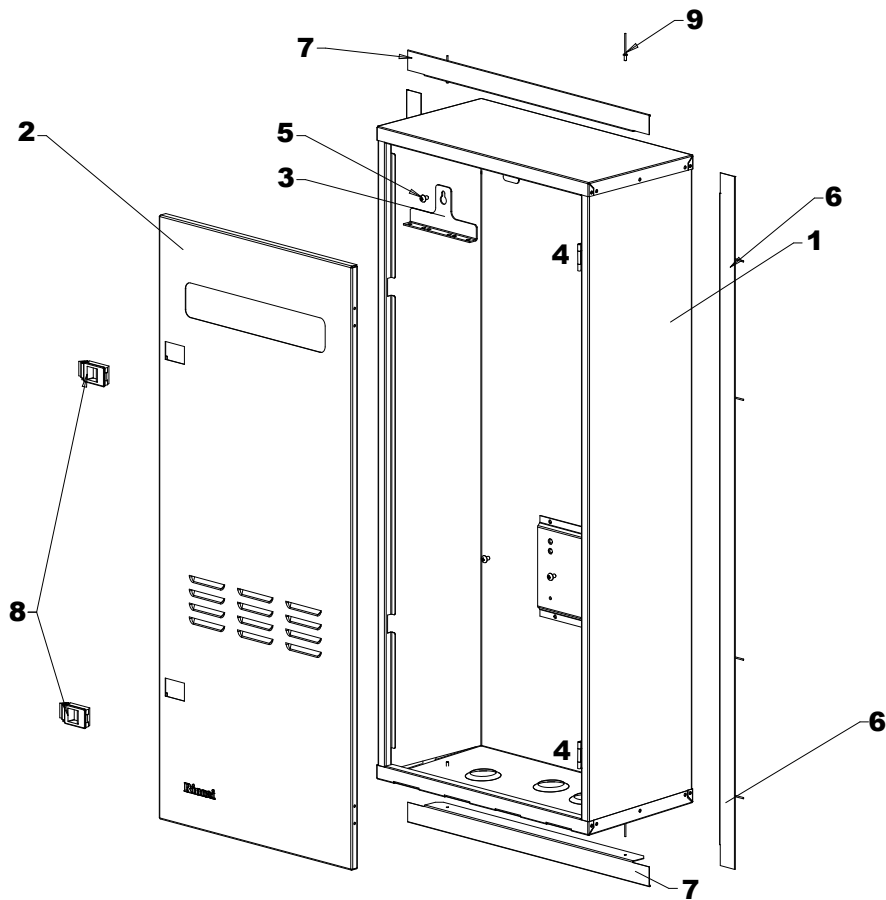

Part number	Description	Quantity
1	Recess box body	1
2	Recess box door	1
3	INFINITY mounting bracket - long (for current A-Series models)	1
4	Stainless steel (304) hinges	2
5	Stainless steel (304) screws M5 x 8	3
6	Side trims	2
7	Top and bottom trims	2
8	Black snap-lock latches	2
9	Stainless steel pop rivets	12

R1407 metal recess box kit contents

HD49kWe, HD250, EF26

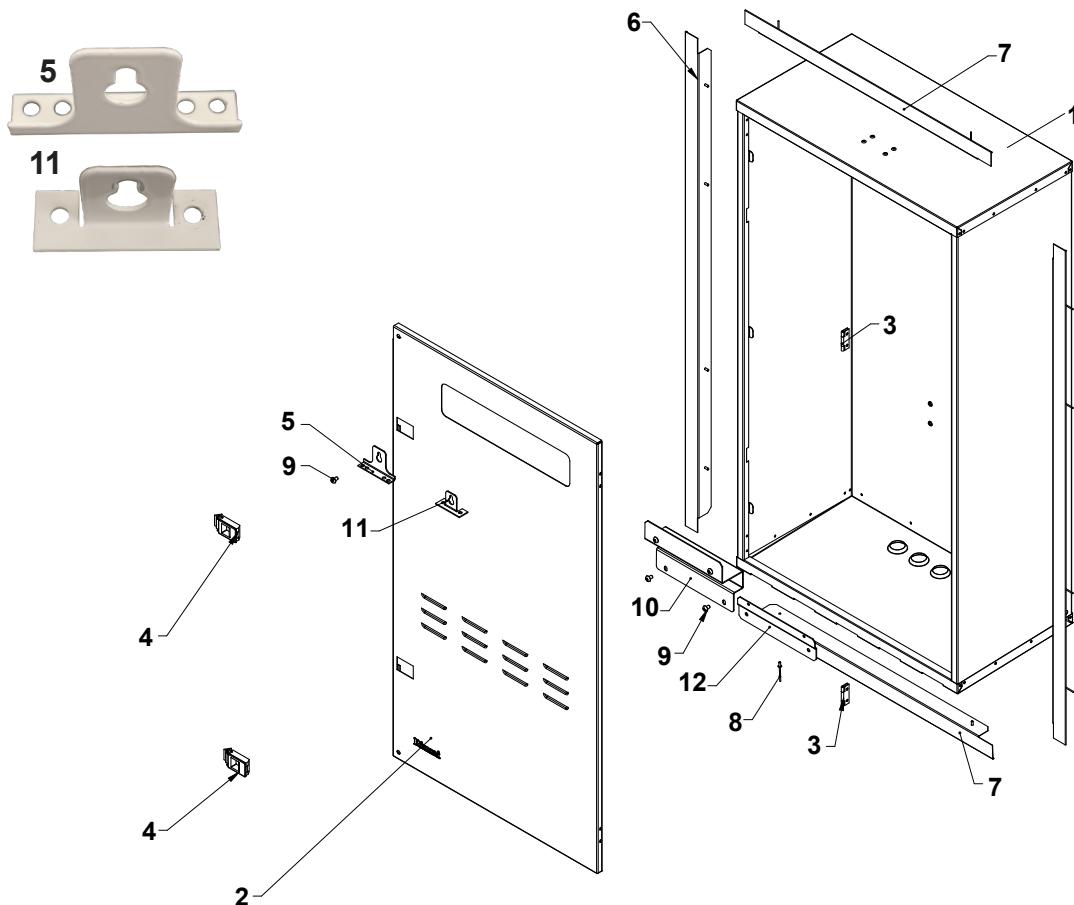

Part number	Description	Quantity
1	Recess box body	1
2	Recess box door	1
3	Stainless steel (304) hinges	2
4	Black snap-lock latches	2
5	EF26 / HD250 top mounting bracket	1
6	Side trims	2
7	Top and bottom trims	2
8	Stainless steel pop rivets	12
9	Stainless steel (304) screws M5 x 8	4
10	EF26 lower adapter bracket	1
11	HD49kWe top mounting bracket	1
12	HD49kWe lower adapter bracket	1

Please note

For an EF26 or H49kWe you will need to install a lower adapter bracket (as pictured), refer images and instructions on p.10 for more information.



Installation steps

1. Framing

Prepare a suitable opening for the recess box and the flashing system intended to be used to ensure the cavity is weathertight.

Make sure there is enough space to run the pipe and electrical connections in the box.

For all installations, regardless of cladding, ensure a 5 mm clearance from all framing and cladding.

2. Attach flashing trims and seal

Position, drill, and use the supplied pop rivets to rivet side, top, and bottom trims around the outside of the box. The position of the trim will depend on the recess depth. The top and bottom trims are positioned **BEHIND** the side trims.

Tape over the trims and box wall joint using waterproof tape (not supplied), taking care to ensure adequate coverage over the joint to prevent water ingress.

3. Install recess box

Install the recess box into the opening. Ensure it is level and square.

Secure the recess box in place by screwing the sides to the framing using appropriate fastenings (not provided).

4. Add flashings

Add appropriate head and side flashings as per the detail in E2 AS1 Fig. 69, thumbnail image reproduced so you know what you're looking for.

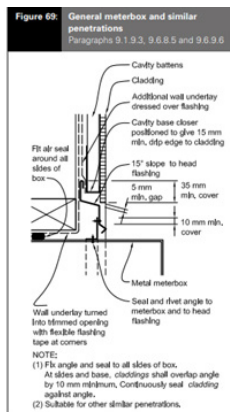

5. Water and gas connections

Run the hot and cold water supplies, and gas connection up into the recess box. It is recommended flexible gas and water connectors are used to make the final connections so the water heater can be removed if necessary without having to cut the pipework.

6. Install a general power outlet

Install an approved weather-proof electrical general power outlet. This can be installed inside the box in accordance with AS/NZS 3000 electrical wiring rules.

7. Copy INFINITY information onto label

The water heater model and serial numbers must be copied legibly from the data plate to the label on the inside of the cover of the recess box before fitting the heater.

The model and serial numbers are required for servicing, troubleshooting, and parts supply.

8. Install the INFINITY into the box

Undo the two screws on top of the water heater and attach the top mounting bracket.

Lift the water heater into the box, sliding the water heater bracket under the top metal pocket of the recess box. Align the screw on the top mounting bracket with the keyhole on the top mounting bracket and tighten.

After the water heater is positioned, align, level and screw the bottom bracket to the back of the box using the screws provided.

The flue outlet of the water heater **MUST** align with the flue outlet position of the door.

Installing an EF26 or HD49kWe

Refer instructions and images on p.10.

9. Complete connections

Connect water, gas, and electrical supplies.

10. Commission water heater

Commission water heater in accordance with the commissioning checklist supplied with the water heater.

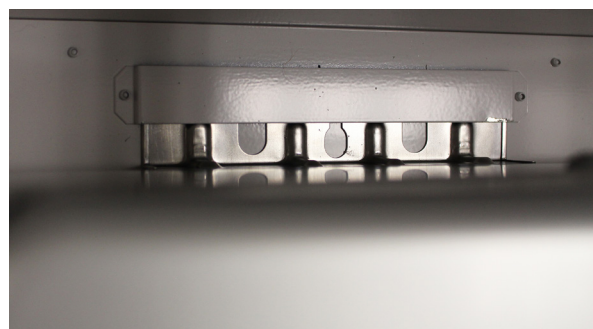

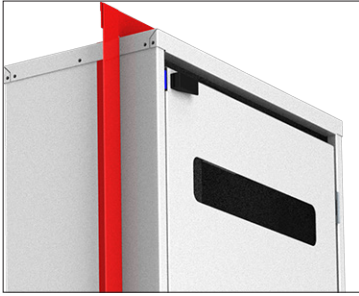

2

Install flashing trims and tape over the flange and box using waterproof tape.

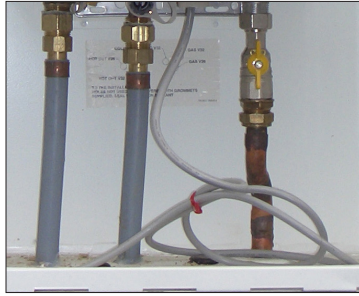

5

Water and gas connections.



6

Install a general power outlet.

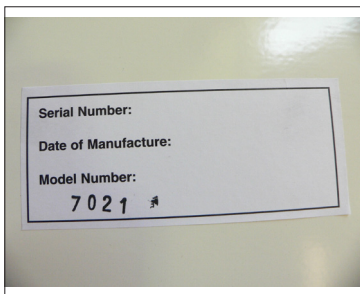

7

Transfer INFINITY data onto label.



8a

Attach mounting bracket to INFINITY.



8b

Slide water heater under back pocket, and align with keyhole on the top mounting bracket.



8c

Level and screw the bottom bracket.



8

Complete connections.



Final

Recess box fully installed and sealed.

Fitting the EF26

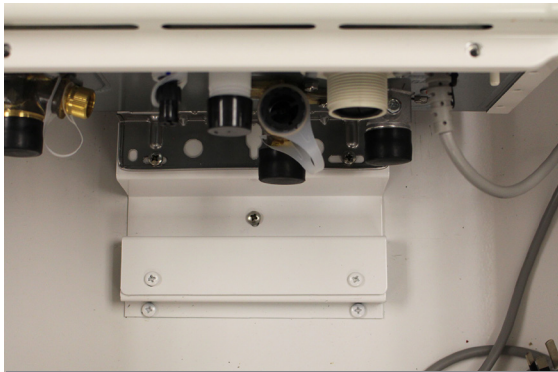

1

Take the EF26 lower adapter from the kit and fit over the existing installed bracket as shown above.

Fitting the HD49kWe

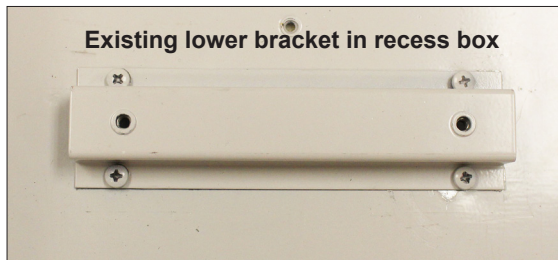

1

Remove the existing lower bracket inside the recess box and discard (recycle).

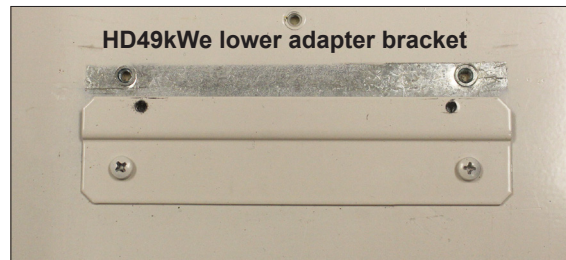

2

From the kit, attach the HD49kWe lower adapter in place. Note position and orientation as pictured.

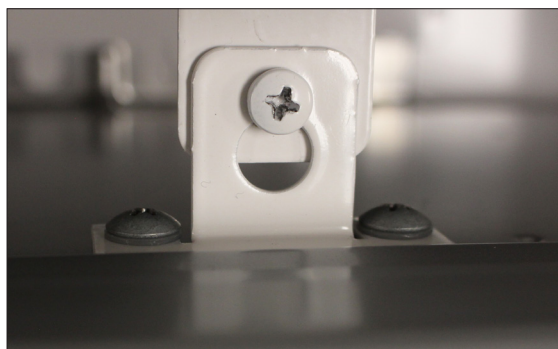

3

Fit the HD49kWe top mounting bracket to unit, lift unit into box, secure back section into metal pocket, and screw top section in place.

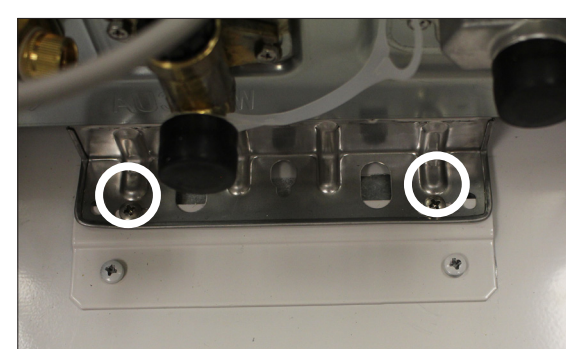

4

Secure water heater bracket to lower adapter as pictured.

Flue terminal clearance positioning diagram

The location of the flue terminal must comply with AS/NZS 5601.1 Fig 6.2. If you are in any doubt as to where to locate the recess box and water heater we recommend contacting a registered gasfitter for advice.

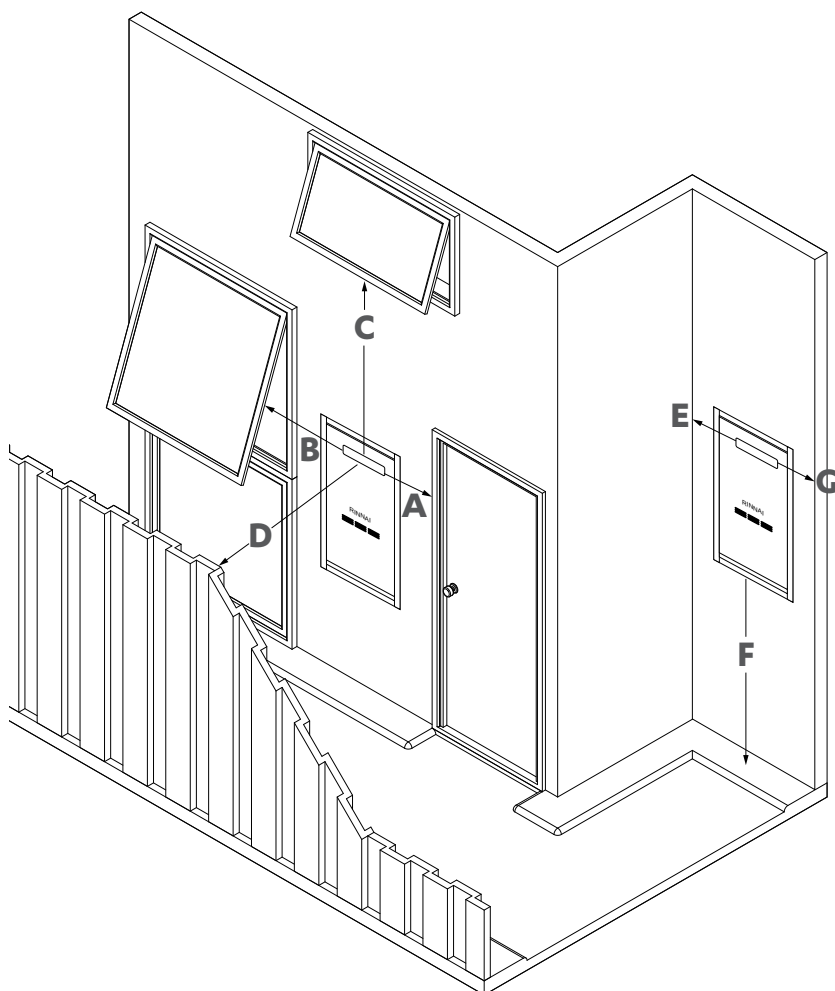

Other general clearances

Below eaves, balconies, and other projections - 300 mm.

From a gas meter - 1000 mm.

From an electricity meter or fuse box - 500 mm.

Description	INFINITY A-Series, EF26	INFINITY HD49kWe, HD250
A Horizontally from an openable door	300 mm	500 mm
B Horizontally from an openable window	300 mm	500 mm
C Vertically below an openable window	1500 mm	1500 mm
D Horizontally from any building structure or obstruction facing the terminal	500 mm	1500 mm
E From a return wall	300 mm	300 mm
F From the ground	300 mm*	300 mm*
G From an external corner	300 mm	300 mm

* Rinnai recommend 1500 mm to give enough clearance for the pipe work and to safely expel flue gases

Rinnai.co.nz

Rinnai New Zealand Limited
105 Pavilion Drive
Mangere, Auckland 2022

PO. Box 53177
Auckland Airport
Auckland 2150

Tel: 0800 746 624
<http://www.youtube.com/rinnainz>
<http://facebook.com.rinnainz>